

Connectors

Features:

- Low insertion loss
- Low back reflection loss
- Easy to handle
- Customer defined specifications
- Environmentally stable

Applications:

- Telecommunications
- Local area network
- Fiber to the home
- Fiber optic sensors
- Testing instruments
- CATV

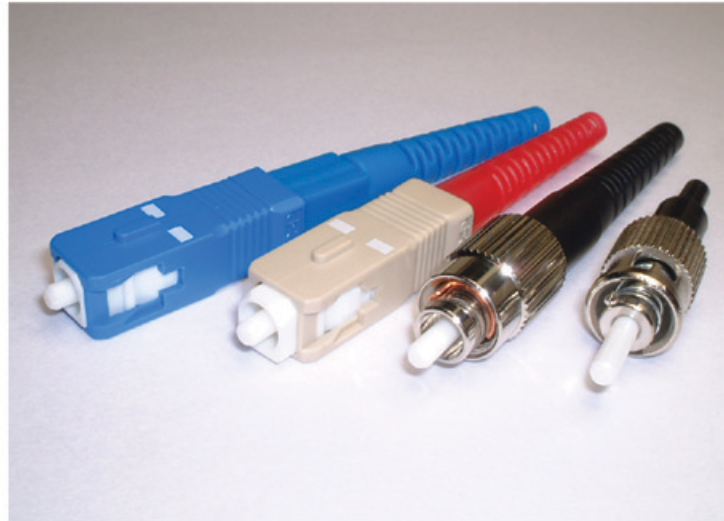

Performance Specifications:

ITEM	Connector Parts	
	Singlemode	Multimode
Mode Type	Singlemode	Multimode
Typical Insertion Loss, dB	0.15	0.3
Typical Return Loss(*), dB	-50	—
Operating Temperature, °C	-40 ~ +75	
Storage Temperature, °C	-55 ~ +85	

Note : * for convex polishing only

CONNECTORS

Mechanical Drawings:

Unit: mm

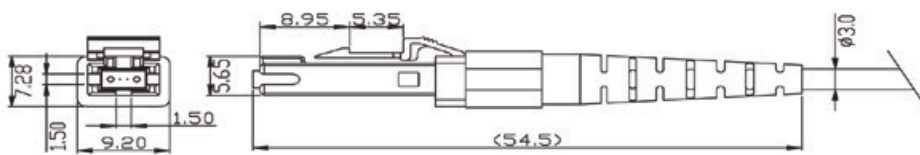
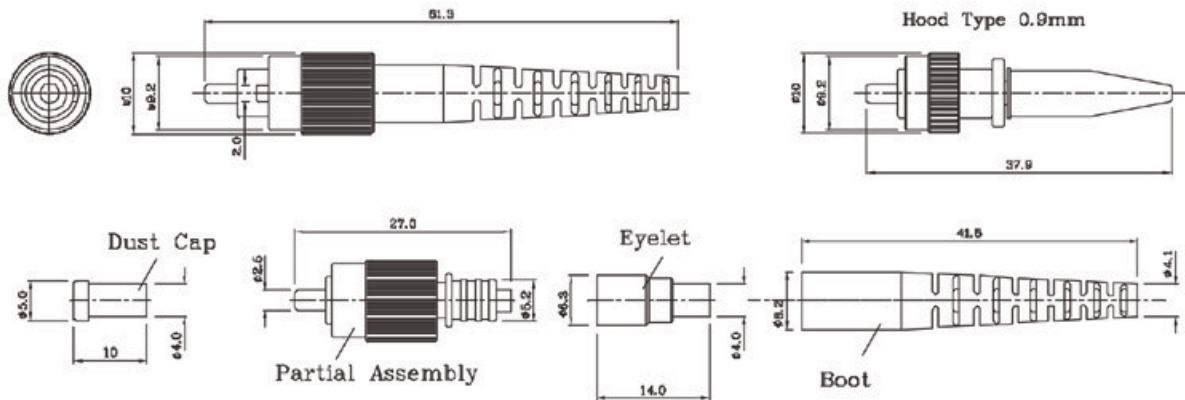
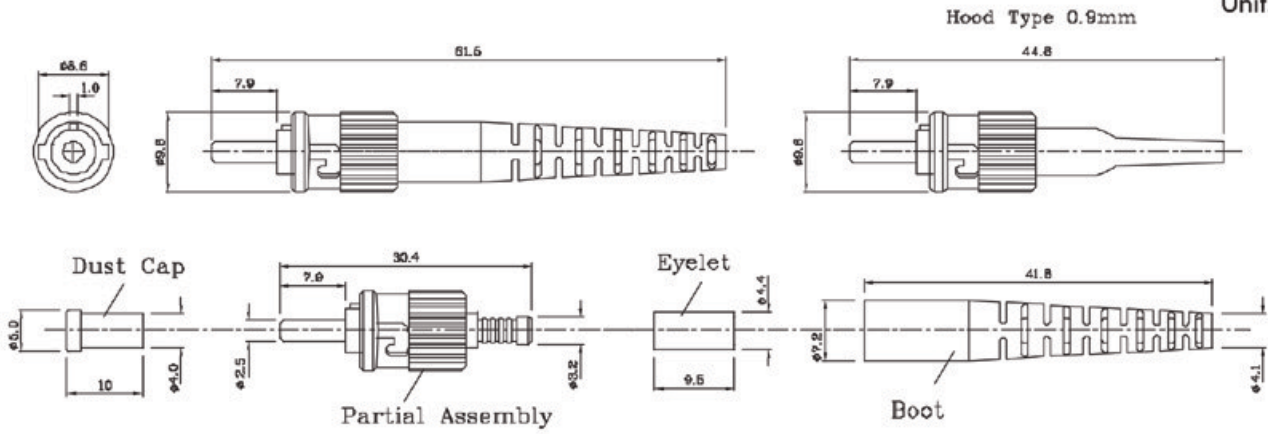

CONNECTORS

Mechanical Drawings:

Unit: mm

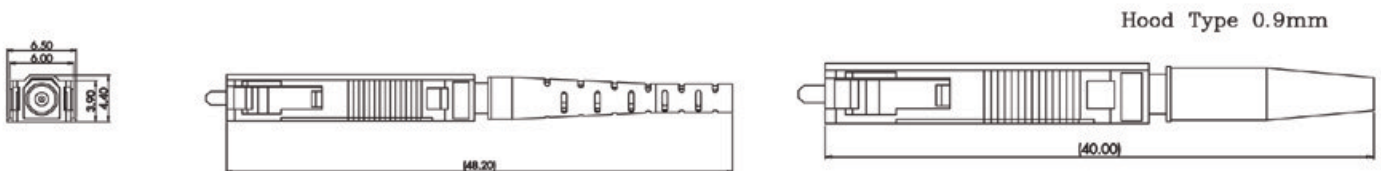
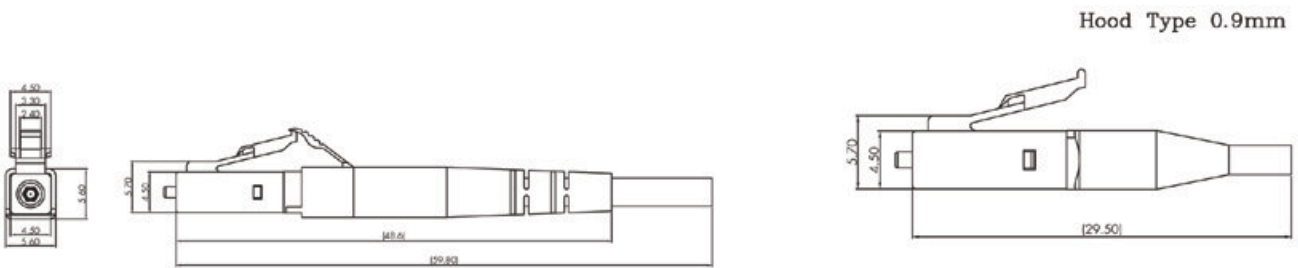
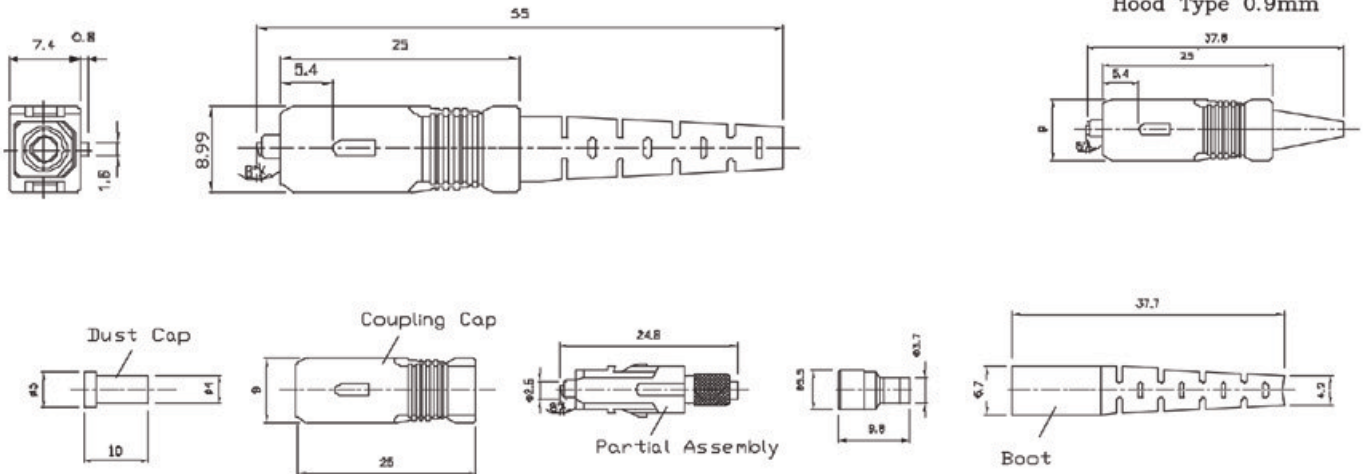

CONNECTORS

Mechanical Drawings:

Unit: mm

Hood Type 0.9mm

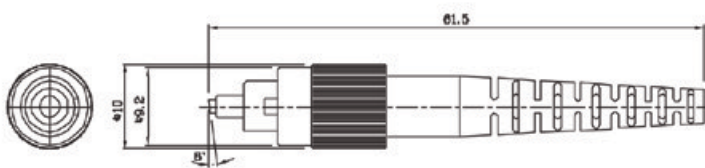
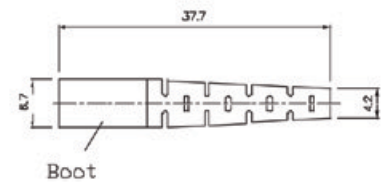
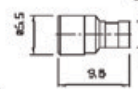
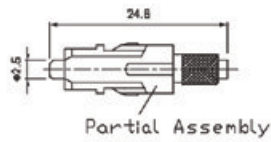
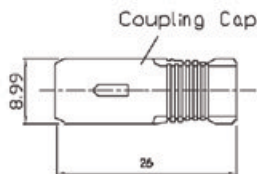
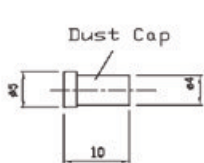
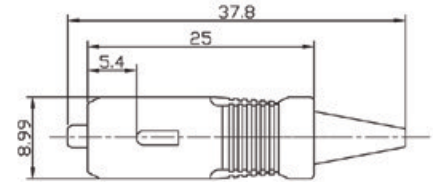
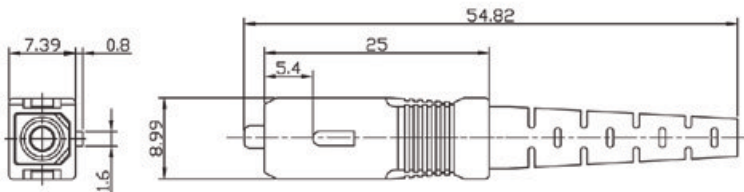

Hood Type 0.9mm

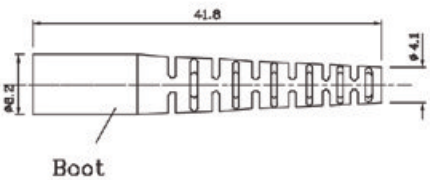
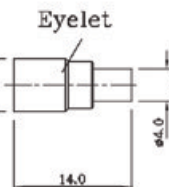
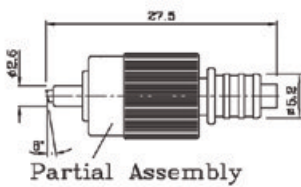
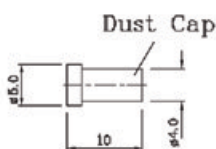
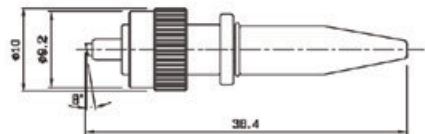

CONNECTORS

Mechanical Drawings:

Unit: mm

